

RYDEEN[®]

find your road



Owner's Manual

MV431T
**Replacement Mirror Monitor System
with Temperature & Compass Display**

v1.1

⚠ WARNINGS ⚠

- **THE FOLLOWING INSTRUCTIONS ARE INTENDED FOR AUTHORIZED RYDEEN MOBILE INSTALLERS ONLY.**
- **PROFESSIONAL INSTALLATION BY AUTHORIZED RYDEEN RETAILER REQUIRED TO BE COVERED UNDER WARRANTY.**
- Dropping your MV411T unit or subjecting it to excessive shock and vibrations as this may cause it to malfunction and is not covered by warranty.
- **The MV431T unit IS NOT WATERPROOF.** Avoid exposing it to rain or other forms of excessive moisture. **Water damage is not covered under the warranty.**

1. Wiring

RED- Accessory

Black- Chassis Ground

Green- Not Used as Video On/Off Switching is Trigger by Video Signal Voltage

Temp. Sensor 1-Interior Temperature Sensor (8 feet)

Temp. Sensor 2-Exterior Temperature Sensor (14 feet)

VIDEO Camera RCA- Video input for camera (priority). The circuit switches automatically when video is sensed by powering up the reverse camera

VIDEO IN RCA- AUX Video input (DVD, MP4 etc.) This circuit is secondary and so it will be over written when Camera video is sensed.

Reassemble all above covers and make connections at knee bolster.

- 1) Connect the camera's 12V and GND wire to reverse tail lamp.
- 2) Connect the camera's RCA to the mirror's Camera input
- 3) Connect the MV431T 12V+ wire to the vehicle's ACC wire.
- 4) Connect the MV431T ground wire (BLACK) to chassis GND

2. Installation

- 1) Remove existing mirror from vehicle.

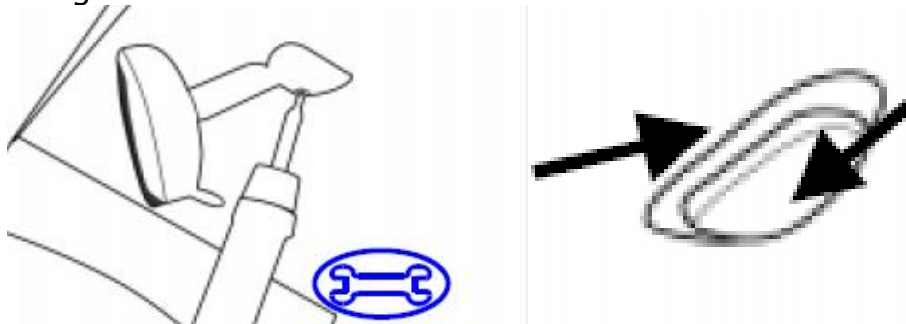

- 2) If existing mirror tab is D-tab style mount MV431T mirror to windshield and go to step 3. If original mirror is not D-tab style or headliner mount go to step 2a.
- 2a) Locate the supplied D-tab and the rearview mirror adhesive and install on windshield as per adhesive instructions.

Note: DO NOT ATTEMPT TO REMOVE THE EXISTING TAB AS DAMAGE TO THE WINDSHIELD MAY OCCUR

- 3) Remove the knee bolster on the driver side as well as the A-pillar cover (it may also be necessary to remove the sun visor and maybe even the overhead console in order to freely route the power harness from the knee bolster to the mirror connector).

Important!

Make sure to route the wire behind the airbag for safety precaution.

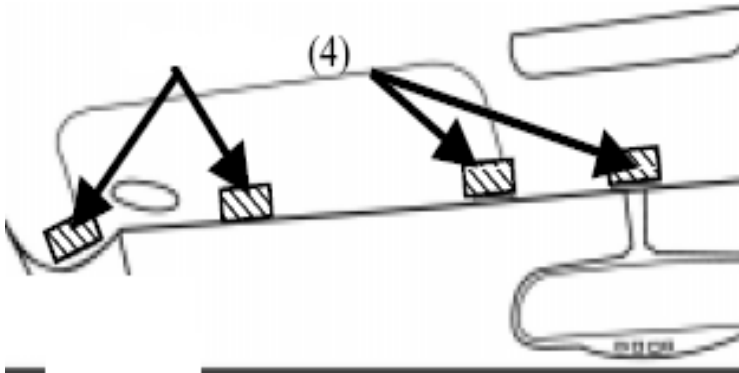

- 4) Install the Exterior Temperature Sensor (longer sensor wire) at Front grill (away from the Engine heat)

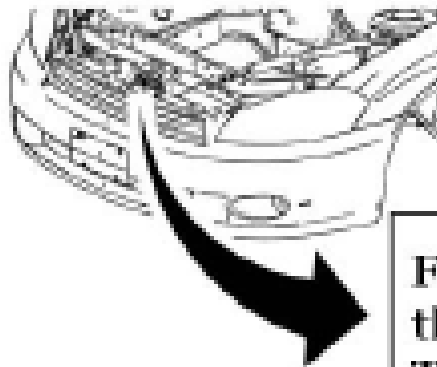

**Front grill for
the Exterior
Temperature
Sensor**

- 5) Install the Interior Temperature Sensor (shorter sensor wire) away from the A/C ventilation through A-pillar

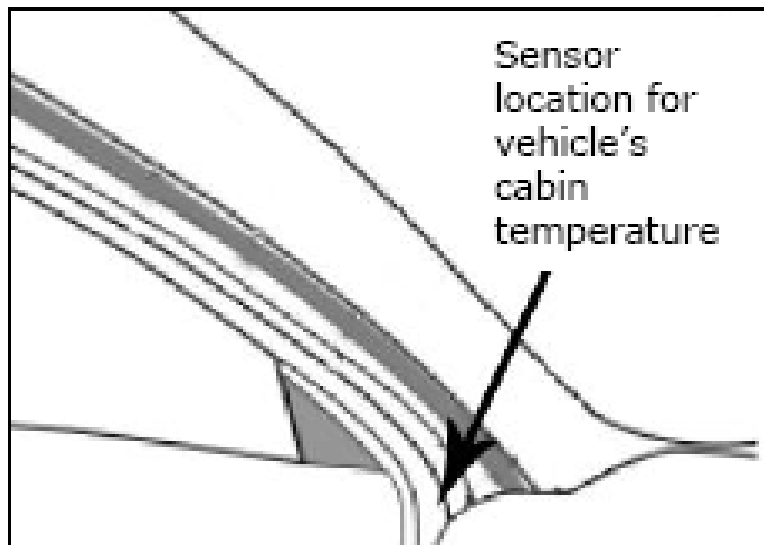

- 6) Install the mirror and connect the power harness to the mirror and use supplied mirror harness wire cover in order to neatly route the cable up the windshield to the headliner.

3. Setup

- 1) Turn Ignition ON
- 2) Parking lines on mirror will turn ON
- 3) If AUX video 1 source was connected (turn video source ON then press PWR button on mirror and the image should appear on screen)
- 4) Shift vehicle into reverse, the camera image will appear on the screen
- 5) Shift vehicle out of reverse and the camera image will disappear and go back to its previous stage
- 6) Press the key  for 3 seconds to change the display.
The mirror has 4 Compass/Temperature display options
 - 1) Display Temperature 1
 - 2) Display Temperature 2 (Display is flashing)
 - 3) Display Compass
 - 4) Display Temperature 2, Temperature 1 & Compass

Display Description

| Display | N | NE | E | SE | S | SW | W | NW |
|---------|-------|---------------|------|---------------|-------|---------------|------|---------------|
| Meaning | North | North East | East | South East | South | South West | West | North West |

| °C | °F | CF | H- | A- | ER | OK |
|---------|------------|---------|------------------------------|---------------------|------------------|------------------|
| Celsius | Fahrenheit | C/F SET | Magnetic Variation Set | Auto Calibration | Error Display | Right Display |

Calibration Description

Key  operation description

Quick Press : Press key less than 1 second

Hold : Hold key for 3 second to 6 second (display flash one time)

Long Hold : Hold key for more than 6 second (display flash two time)

Hold  for 3 seconds to switch display (Temp 1, 2 & Compass)

Display Calibration

Celsius/Fahrenheit Settings

Hold  for 6 seconds to enter Settings

Select C (Celsius) or F (Fahrenheit) by pressing the  once.

Hold  for 3 seconds to save and enter to Compass Settings

Manual Compass Calibration “H-”

Press  once to adjust Compass (- 25° ~ + 25°)

Find out the magnetic declination of the certain area.

Automatic Compass Calibration “A-”

Hold  for 3 seconds to save the previous setting then enters the **Automatic Compass Calibration “A-”**.

The mirror will start counting from 0-200

Starting from 20 seconds, put the vehicle in drive and drive the vehicle less than 5MPH going counter clockwise.

Important!

Performing this calibration process require a clear area to drive the vehicle in circles to calibrate the compass properly.

After 2 laps of counter clockwise, press and hold  for 3 seconds to enter setup.

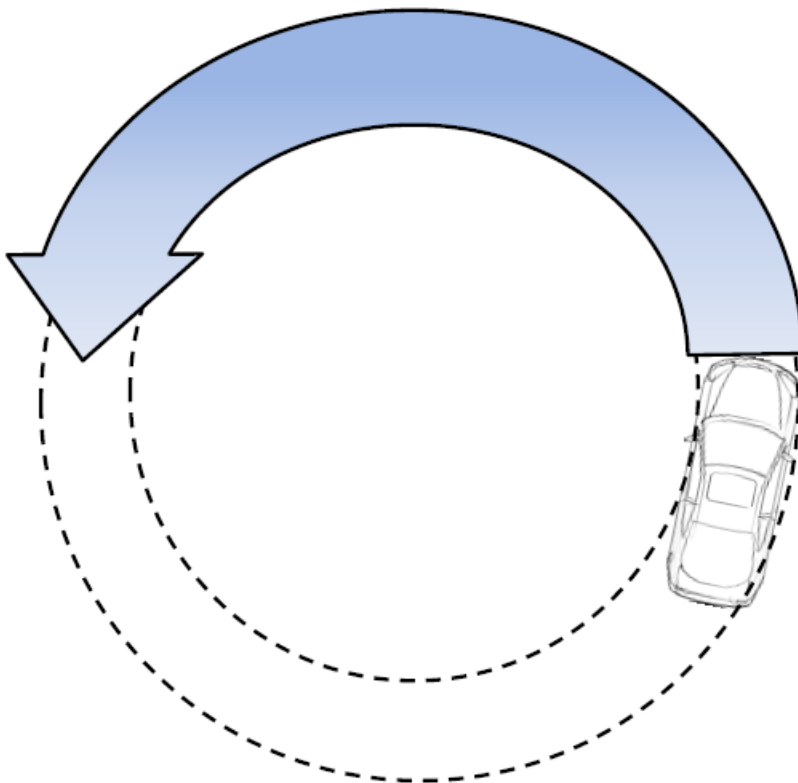

After calibrating the compass, you may exit the settings mode and test the mirror’s compass and temperature.

If  button is pressed for 1 second, it is considered as invalid and the mirror will display “ER” as error.

4. Power Button Operation

Press and Hold  Key for 3 seconds to switch display (Temp2, Temp1, Compass or Temp2, Temp1 Compass cycle)

Press  once to turn ON/OFF temperature/compass display

Press and Hold  key for 6 seconds to enter settings

5. Removable Mount Structure

MV431T is equipped with the removable mounting stem structure, which allows to exchange with the following available ball joint mounting stems.



6. Trouble Shooting

Q: The Green LED never turns ON and I do not get a picture?

A: Test to confirm that (+ & -) are connected properly and fuse is good.

Q: The Green LED is ON but I do not see any picture?

A: Make sure that the video RCA's are connected properly and that the camera is powered up properly as per camera instructions.

Q: The Green LED is always ON?

A: It's a light indicator to show the mirror is receiving voltage.

Q: The image on the mirror is opposite (left is right and right is left) what is wrong?

A: The **White** jumper on the camera harness is connected (should be cut in half).

Q: I do NOT like the parking lines, how can I turn them OFF?

A: Connect the **Green** jumper at the camera harness to turn the parking line feature OFF.

7. Technical Support Contact Info

If you have other questions about the **RYDEEN MV431T**, please contact your retailer or Technical Support:

- Telephone: **1-877-777-8811 (within USA only)**
- Email: **tech1@rydeenmobile.com**
- Web Address: www.rydeenmobile.com

One Year Limited Warranty

Rydeen North America Inc. (a manufacturer of "RYDEEN" products) warrants this product (MV431T) only to the original purchaser as described by the following:

Warranty Period

Rydeen warrants this product for a period of one (1) year from the original purchase date.

Warranty Coverage

This warranty covers all defects in material and workmanship except as specified below.

1. Installation by anyone other than an authorized RYDEEN retailer voids the warranty.
2. Any products distributed outside of the USA by Rydeen North America Inc. (RYDEEN) or which is not purchased in the USA or Canada unless the product is purchased through the USA Military Exchange Service.
3. Any product(s) which are purchased from an unauthorized retailer (in store or online).
4. Any products in which the serial number label or the model number label are removed, torn, modified or replicated.
5. Any damage defects or malfunctions resulting from any of following:
 - a) When defect occurs during shipment of product (freight carrier's responsibility).
 - b) Installation or removal of product.
 - c) Accidents, act of nature, misuse, abuse, neglect, unauthorized product modification or failure to follow product owner's manual instructions.
 - d) Any repair or attempt to repair without RYDEEN authorization.
 - e) Any other cause which is not related to product defect.
 - f) Any cosmetic damages due to normal wear and tear.
 - g) Any consumable items (such as fuse or batteries).

If any problems develop with your RYDEEN products during or after the Limited Warranty Period, or if you have any questions regarding the operation or installation of the product, you should contact your RYDEEN retailer. If the problem or your question is not handled to your satisfaction, please contact Rydeen Customer Service Department at 1-877-777-8811 (within the USA only) Monday - Friday between 9:00 AM to 4:00 PM Pacific Standard Time or visit www.rydeenmobile.com.



www.rydeenmobile.com

Rydeen North America Inc.
dba Rydeen Mobile Electronics
2701 Plaza Del Amo, Suite 705, Torrance, California 90503 USA
Phone: 1-877-777-8811 Fax: 1-310-943-3778

Copyright © 2013 Rydeen North America Inc. All Rights Reserved.

These materials are protected by copyright law and international treaties. Any unauthorized use, reproduction or distribution of these materials, or any portion herein, will result in severe civil and criminal penalties and fines. Violators will be prosecuted to the fullest extent of the law.