

## Quick Reference Guide

### Included Items



MiNy360 Main Unit



Dashboard Bracket x 1 (B)



Electrostatic Sticker x 1



Cigarette Lighter x 1 (D) & Power Adapter Cable x 1 (A)

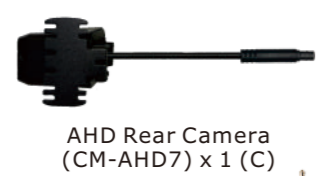

AHD Rear Camera (CM-AHD7) x 1 (C)



28ft AHD Camera Extension Cable x 1 (C)



27° Wedge Bracket x 1 (B)



21° Wedge Bracket x 1 (B)



Pry Tool x 1



32GB SD Card x 1

## Getting Started

### 1. Installation Method

#### Windshield Installation Method

Install the suitable windshield bracket (27° or 21°) and attach the MiNy360 to the appropriate position on the windshield.

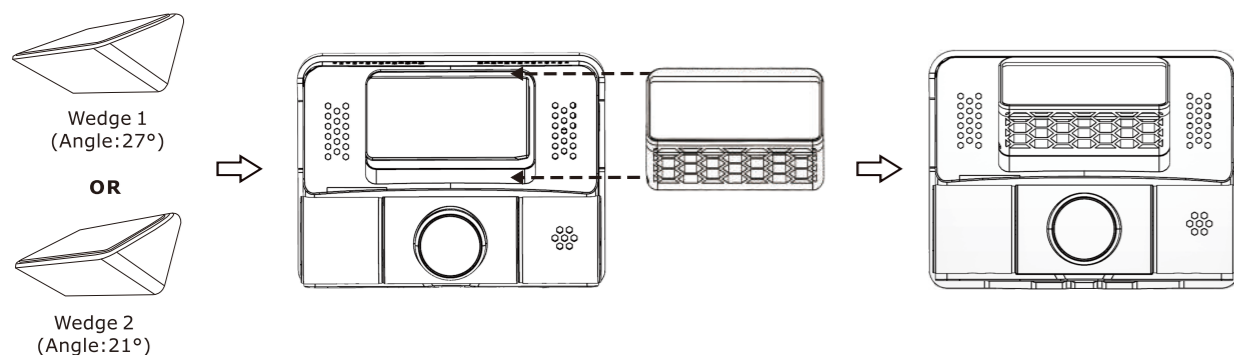

#### Dashboard Installation Method

Install the dashboard bracket and attach the MiNy360 in a suitable position on the dashboard.

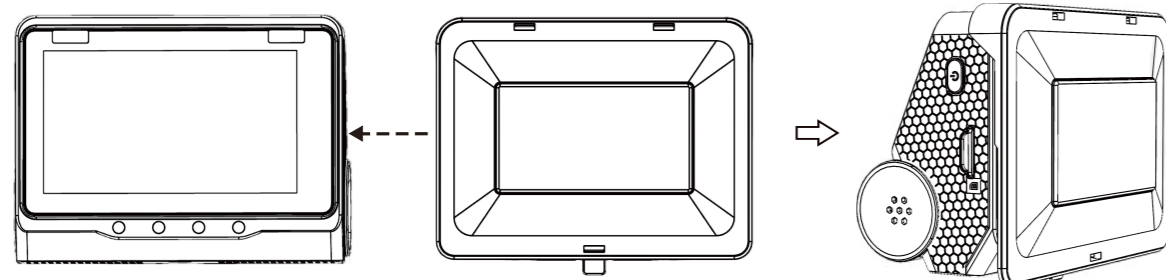

Windshield Installation



Dashboard Installation

#### Note:

Please select an installation location that does not obstruct the driver's view of the road. Make sure the device is positioned in a way that does not interfere with normal driving visibility or block any critical sightlines, ensuring safe and comfortable operation at all times.

### 2. Wiring Diagram

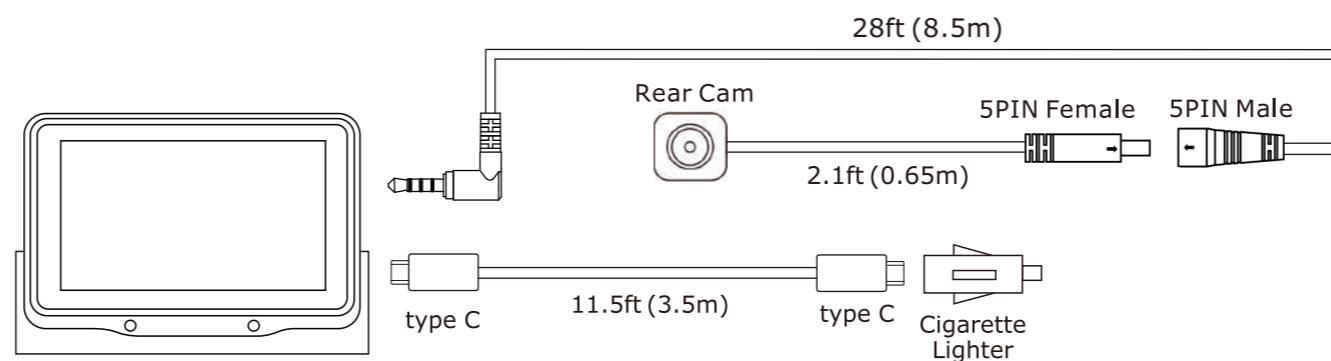

For Cars

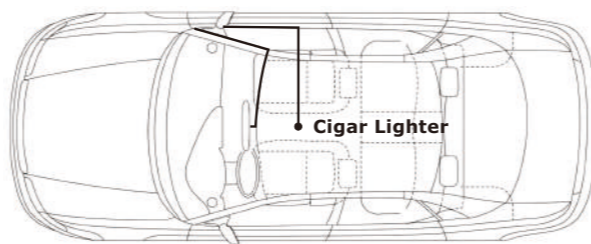

For Trucks

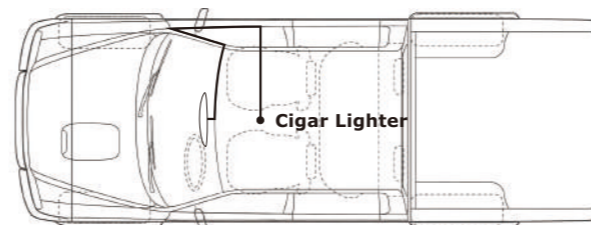

Inside View

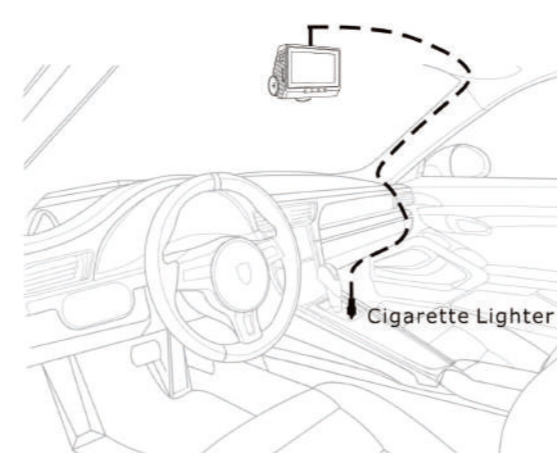

### 3. Backup camera installation position option diagram

(1) Rear windshield mounting location (interior top mounted) with optional BRK01 bracket (not included)      (2) Above license plate mounting location (Exterior Mounted)

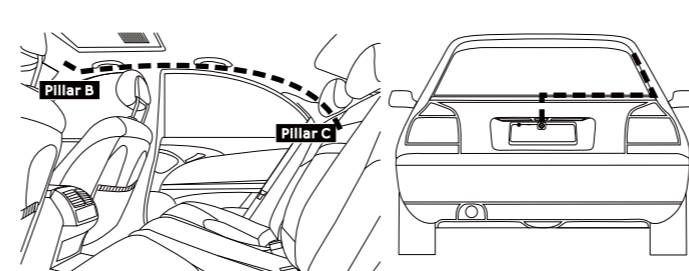
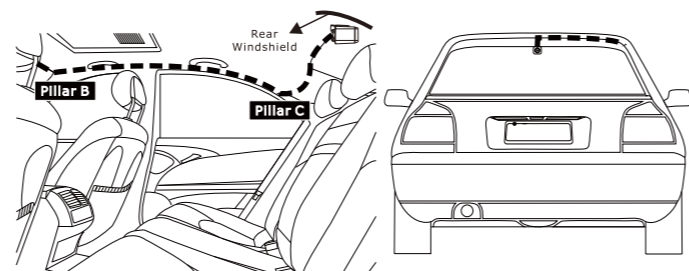

## Touchscreen Operation

### 4. Main User Interface



**Video Recording**  
Start or stop video recording.

**Photo Capture**  
Take a photo.

**File Lock**  
Start emergency (SOS) recording and lock the current file.

**Audio Recording**  
Enable or disable audio recording.

**Settings**  
Access system settings.

**Display Modes**  
Switch display modes.

**Playback**  
Review recorded videos and photos.

**IR (Night Vision)**  
Turn infrared night vision on or off.

### 5. Settings

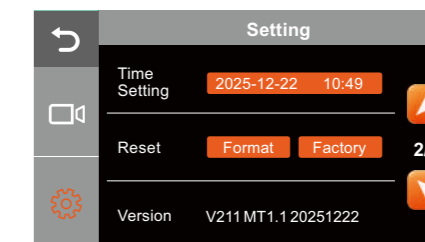
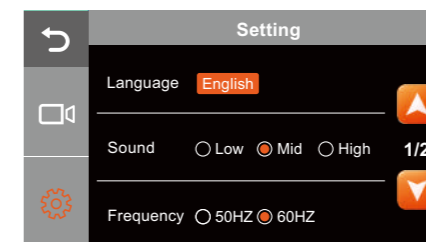
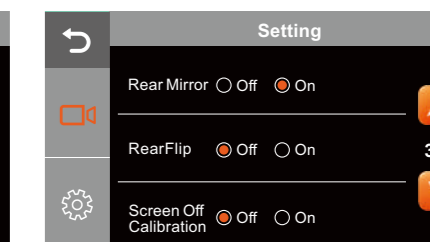
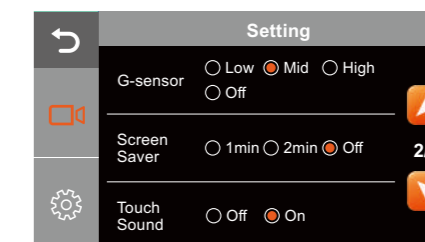
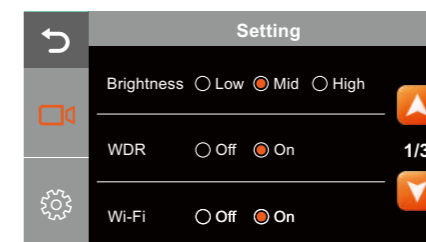

### 6. Two Modes

#### Split Mode



#### 360° Mode

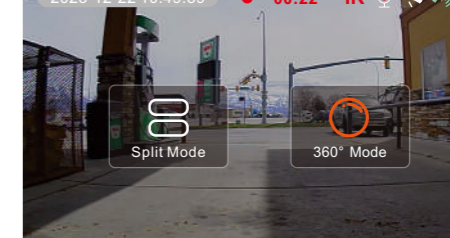

## Technical Support Contact Info

For any questions about **MiNy360**, please contact your retailer or RYDEEN Technical Support:

- Phone: **1-310-787-7880**      Fax: **1-310-787-7881**
- Email: [tech1@rydeenmobile.com](mailto:tech1@rydeenmobile.com)
- Web: <https://rydeenmobile.com/contact-support/>

## Guide de référence rapide

### Contenu de l'emballage

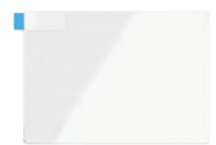

Unité principale MiNy360

Support de tableau de bord x 1 (B)

Autocollant électrostatique x 1

Allume-cigare x 1 (A) & Câble adaptateur d'alimentation x 1 (D)

Caméra arrière AHD (CM-AHD7) x 1 (C)

27° Support en coin x 1 (B)

Outil de démontage x 1

Câble d'extension caméra AHD (28 ft) x 1 (C)

21° Support en coin x 1 (B)

Carte SD 32 Go x 1

## Prise en main

### 1. Méthode d'installation

#### Méthode d'installation sur le pare-brise

Installez le support de pare-brise approprié (27° ou 21°), puis fixez le MiNy360 à l'emplacement adéquat sur le pare-brise.

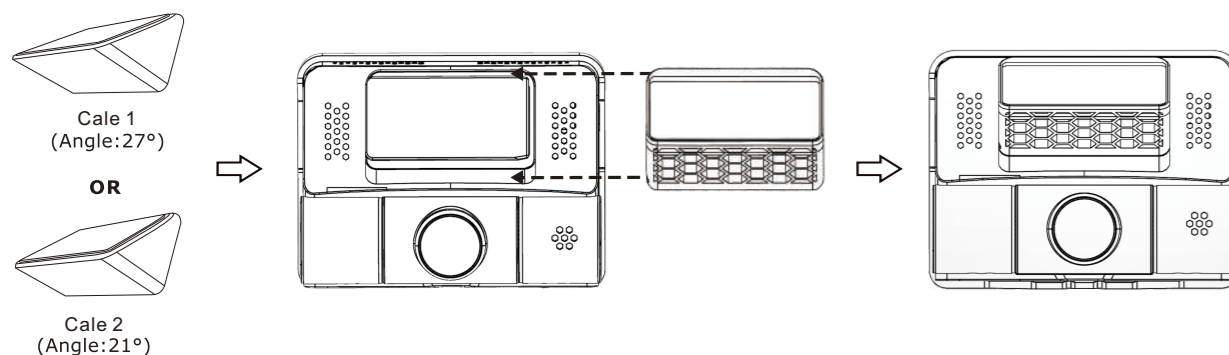

#### Méthode d'installation sur le tableau de bord

Installez le support de tableau de bord, puis fixez le MiNy360 à un emplacement approprié sur le tableau de bord.

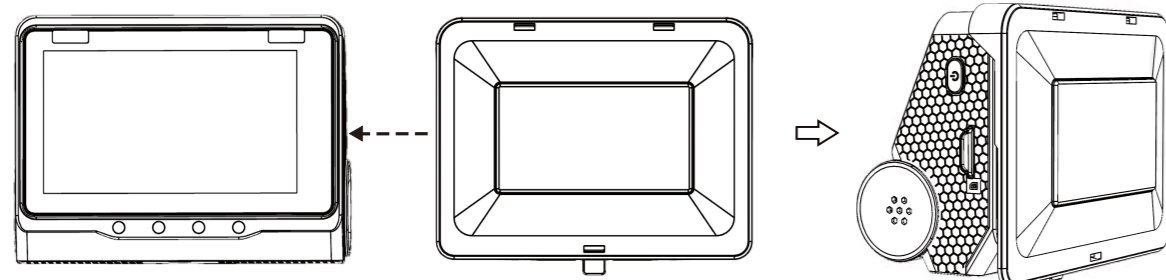

Installation sur le pare-brise



Installation sur le tableau de bord

#### Note:

Veillez choisir un emplacement d'installation qui n'obstrue pas la vue de la route par le conducteur. Assurez-vous que l'appareil est positionné de manière à ne pas gêner la visibilité normale de conduite ni bloquer les lignes de vue essentielles, afin de garantir une utilisation sûre et confortable à tout moment.

### 2. Schéma de câblage

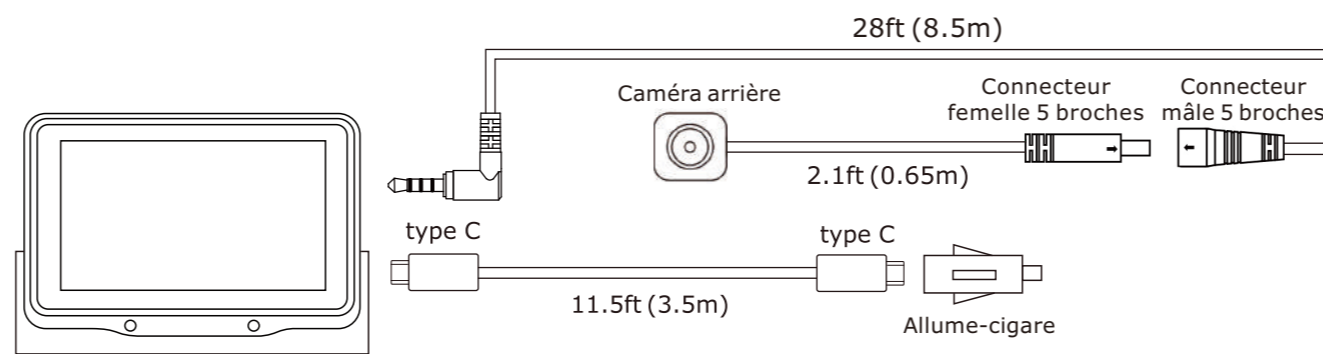

Pour véhicule

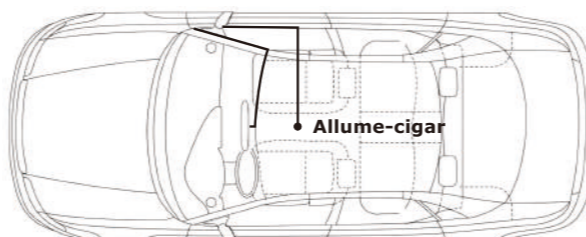

Vue intérieure

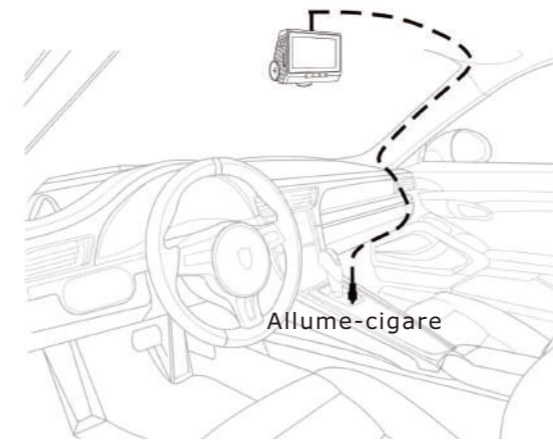

Pour camions

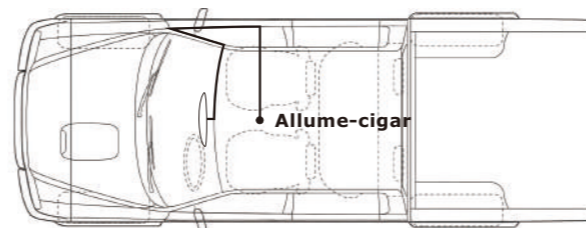

### 3. Schéma des options de position d'installation de la caméra de recul

(1) Emplacement de montage sur la lunette arrière (installation intérieure en haut) avec support BRK01 en option (non inclus)

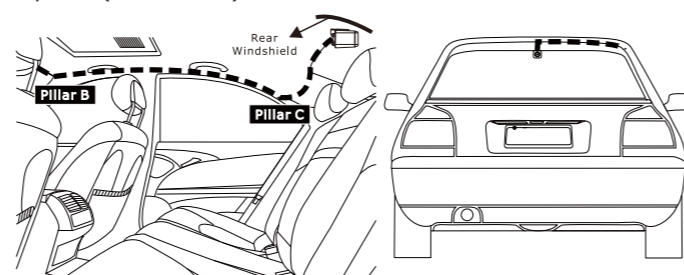

(2) Emplacement de montage au-dessus de la plaque d'immatriculation (installation extérieure)

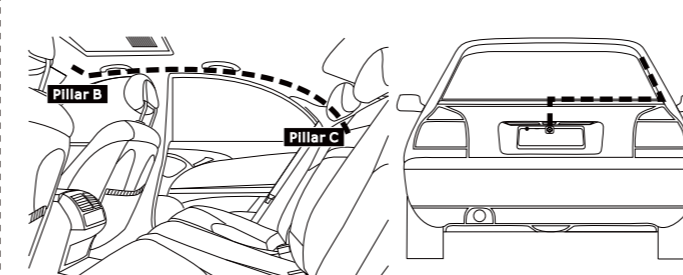

## Fonctionnement de l'écran tactile

### 4. Interface utilisateur principale



- Enregistrement vidéo**  
Démarrer ou arrêter l'enregistrement vidéo.
- Paramètres**  
Accéder aux paramètres du système.
- Capture photo**  
Prendre une photo.
- Modes d'affichage**  
Changer de mode d'affichage.
- Verrouillage de fichier**  
Démarrer l'enregistrement d'urgence (SOS) et verrouiller le fichier en cours.
- Lecture**  
Consulter les vidéos et photos enregistrées.
- Enregistrement audio**  
Activer ou désactiver l'enregistrement audio.
- IR (vision nocturne)**  
Activer ou désactiver la vision nocturne infrarouge.

### 5. Paramètres

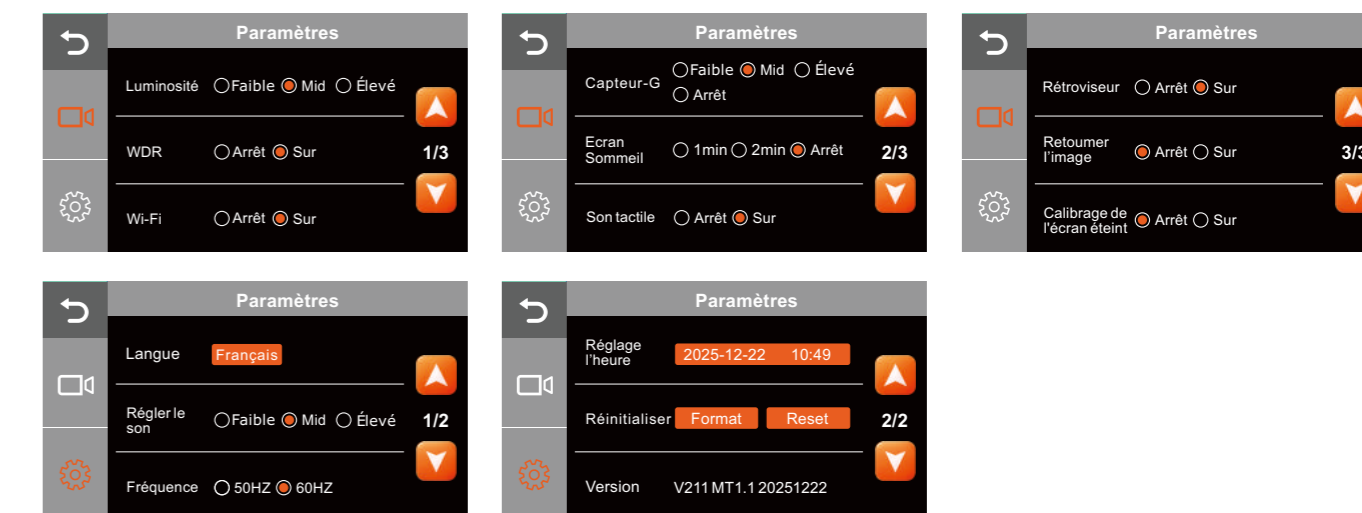

### 6. Deux Modes

#### Mode fractionné

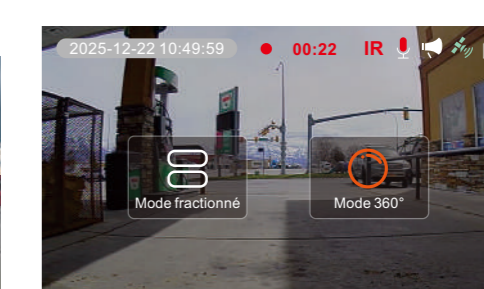

#### Mode 360°

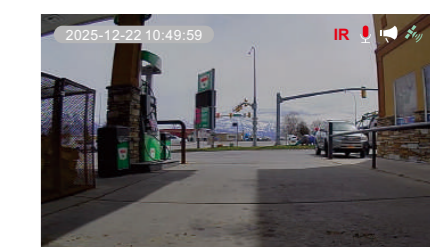

## Coordonnées du support technique

Pour toute question concernant le **MiNy360**, veuillez contacter votre revendeur ou le support technique RYDEEN :

- Téléphone: **1-310-787-7880** Fax: **1-310-787-7881**
- Email: [tech1@rydeenmobile.com](mailto:tech1@rydeenmobile.com)
- Web: <https://rydeenmobile.com/contact-support/>