

Quick Reference Guide

Included Items



Dashboard Bracket x 1 (B)

Electrostatic Sticker x 1

Power Wire Harness with Proximity Radar x 1 (A)



AHD Rear Camera (CM-AHD7) x 1 (C)

27° Wedge Bracket x 1 (B)

32GB SD Card x 1



28ft AHD Camera Extension Cable x 1 (C)

21° Wedge Bracket x 1 (B)

MiNy360X Main Unit

Getting Started

1. Installation Method

Windshield Installation Method

Install the suitable windshield bracket (27° or 21°) and attach the MiNy360X to the appropriate position on the windshield.

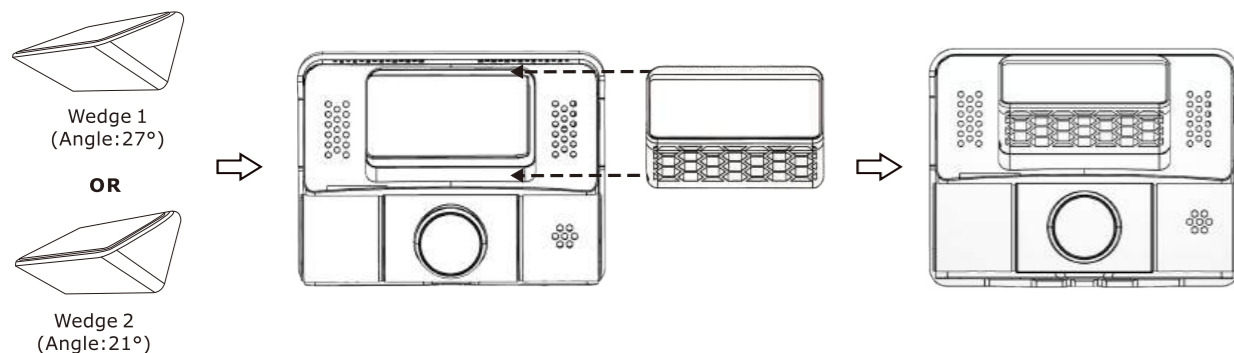

Dashboard Installation Method

Install the dashboard bracket and attach the MiNy360X in a suitable position on the dashboard.

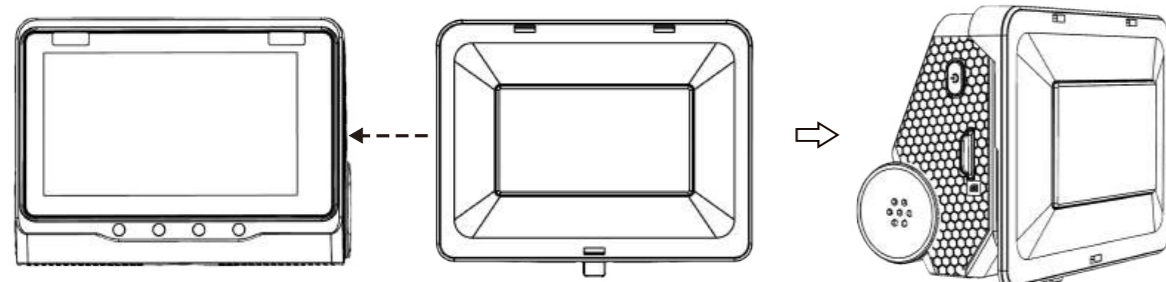

Windshield Installation



Dashboard Installation

Note:

Please select an installation location that does not obstruct the driver's view of the road. Make sure the device is positioned in a way that does not interfere with normal driving visibility or block any critical sightlines, ensuring safe and comfortable operation at all times.

2. Wiring Diagram

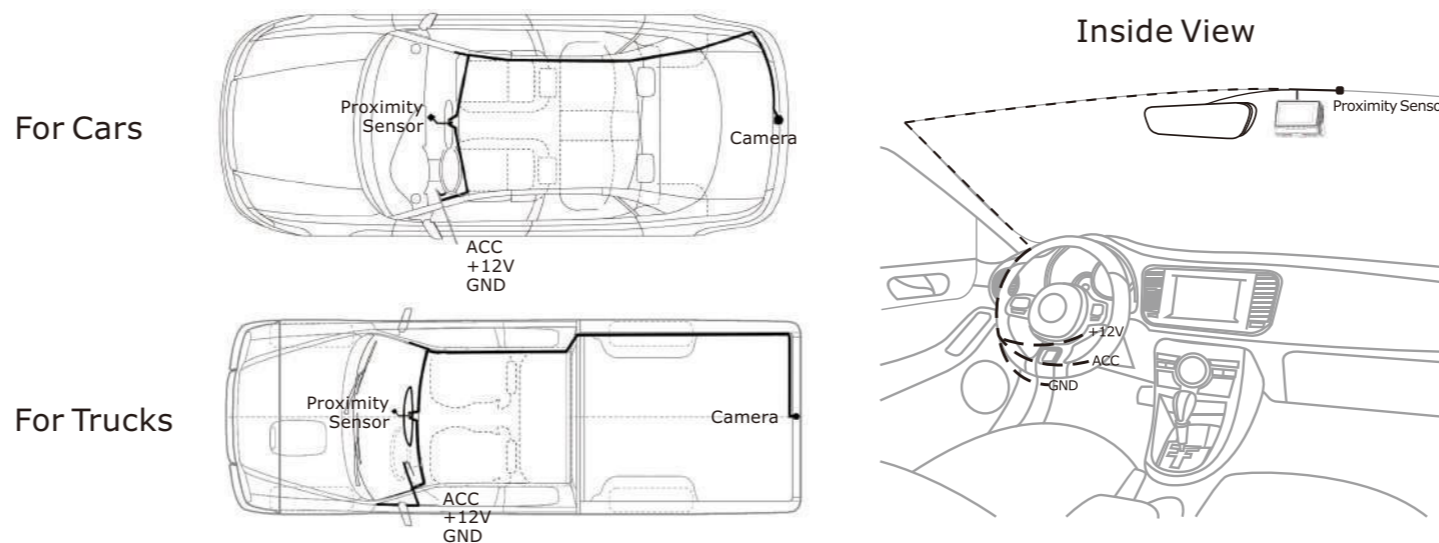
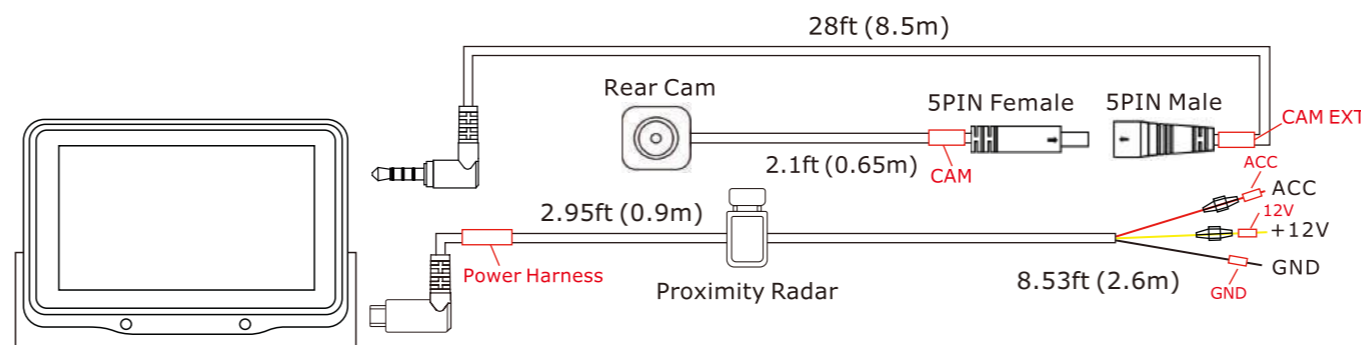

3. Backup camera installation position option diagram

(1) Rear windshield mounting location (interior top mounted) with optional BRK01 bracket (not included)

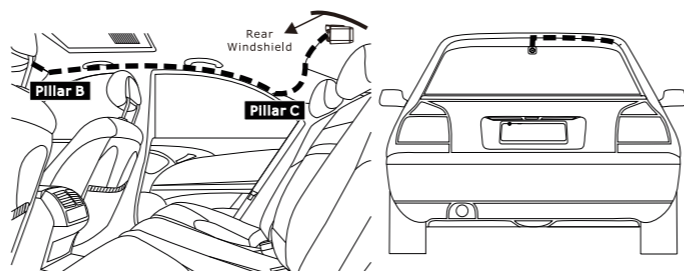

(2) Above license plate mounting location (Exterior Mounted)

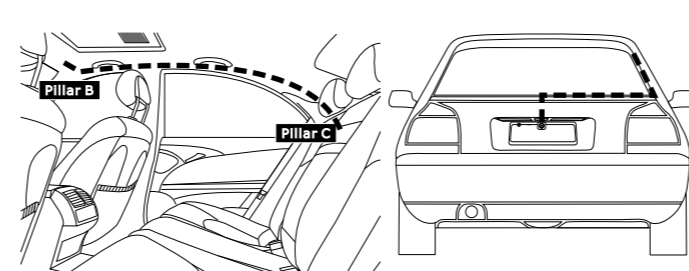

Touchscreen Operation

4. Main User Interface



Video Recording
Start or stop video recording.

Photo Capture
Take a photo.

File Lock
Start emergency (SOS) recording and lock the current file.

Audio Recording
Enable or disable audio recording.

Settings
Access system settings.

Display Modes
Switch display modes.

Playback
Review recorded videos and photos.

IR (Night Vision)
Turn infrared night vision on or off.

5. Settings

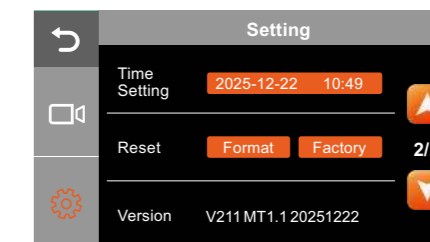
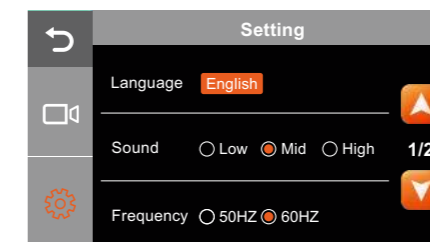
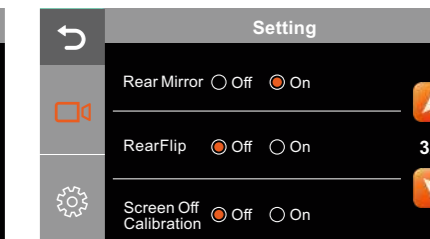
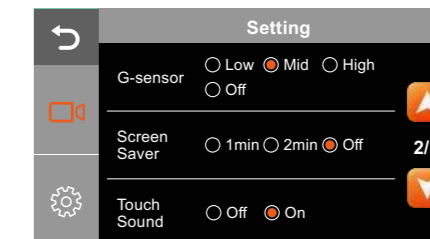
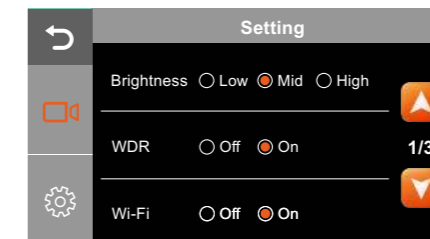

6. Two Modes

Split Mode

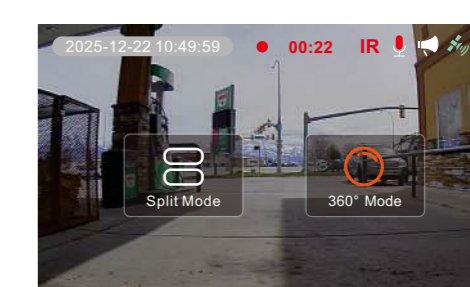

360° Mode

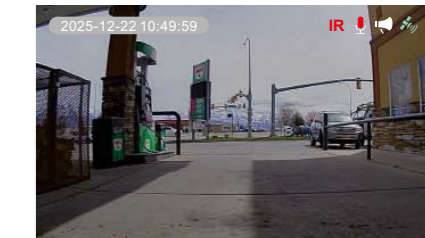

Technical Support Contact Info

For any questions about **MiNy360X**, please contact your retailer or RYDEEN Technical Support:

- Phone: **1-310-787-7880** Fax: **1-310-787-7881**
- Email: tech1@rydeenmobile.com
- Web: <https://rydeenmobile.com/contact-support/>

Guide de référence rapide

Contenu de l'emballage

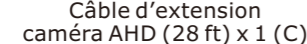

Unité principale MiNy360X

Prise en main

1. Méthode d'installation

Méthode d'installation sur le pare-brise

Installez le support de pare-brise approprié (27° ou 21°), puis fixez le MiNy360X à l'emplacement adéquat sur le pare-brise.

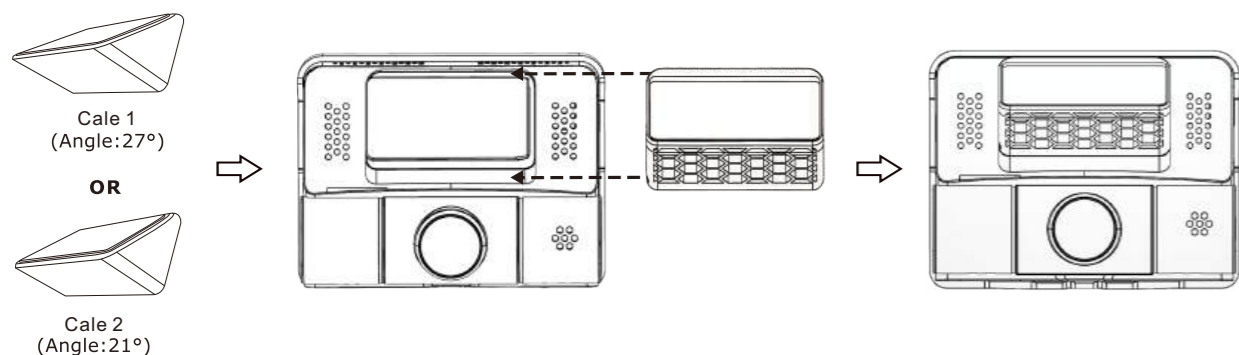

Méthode d'installation sur le tableau de bord

Installez le support de tableau de bord, puis fixez le MiNy360X à un emplacement approprié sur le tableau de bord.

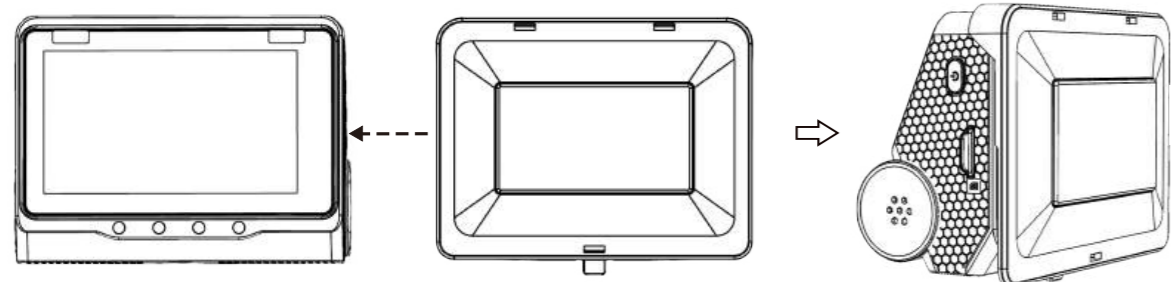

Installation sur le pare-brise



Installation sur le tableau de bord

Note:

Veillez choisir un emplacement d'installation qui n'obstrue pas la vue de la route par le conducteur. Assurez-vous que l'appareil est positionné de manière à ne pas gêner la visibilité normale de conduite ni bloquer les lignes de vue essentielles, afin de garantir une utilisation sûre et confortable à tout moment.

2. Schéma de câblage

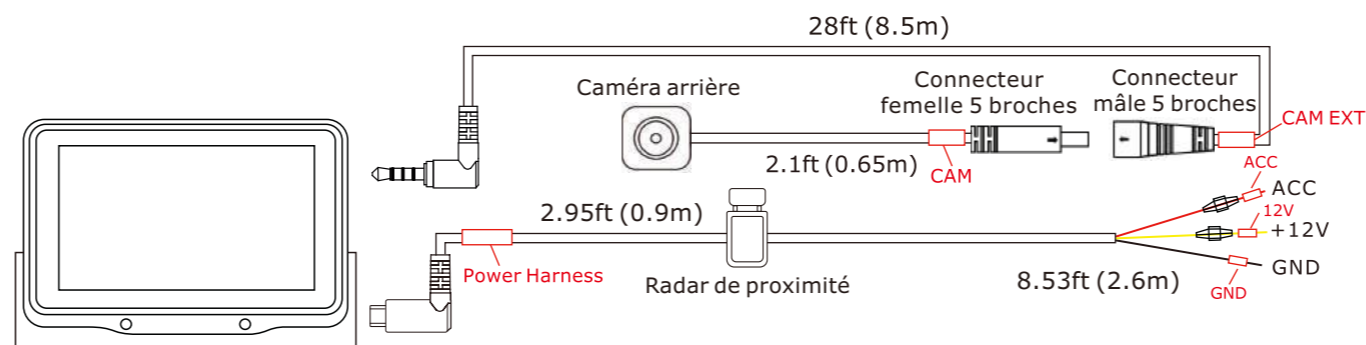

Pour véhicule

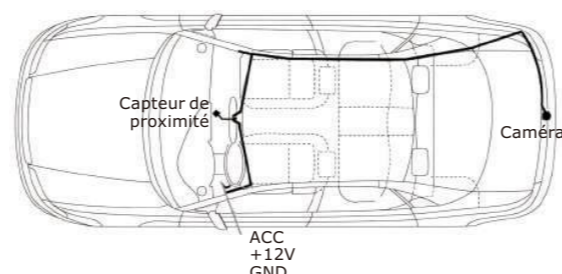

Pour camions

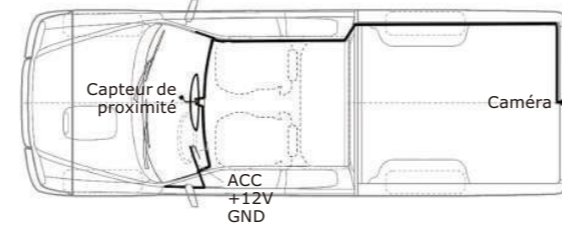

Vue intérieure

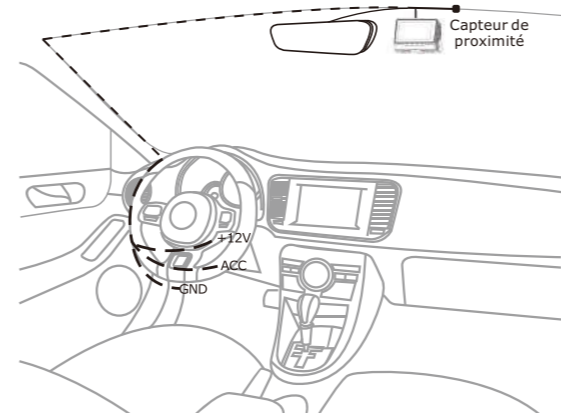

3. Schéma des options de position d'installation de la caméra de recul

(1) Emplacement de montage sur la lunette arrière (installation intérieure en haut) avec support BRK01 en option (non inclus)

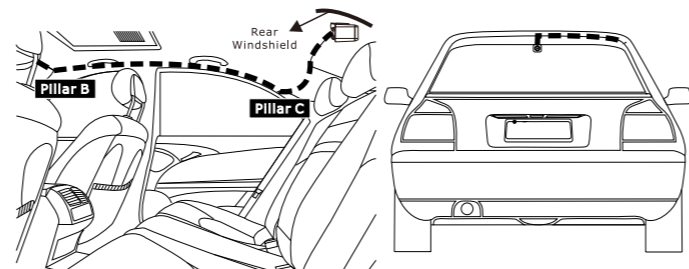

(2) Emplacement de montage au-dessus de la plaque d'immatriculation (installation extérieure)

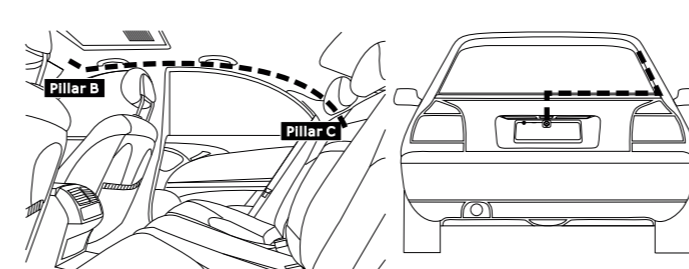

Fonctionnement de l'écran tactile

4. Interface utilisateur principale



- Enregistrement vidéo**
Démarrer ou arrêter l'enregistrement vidéo.
- Paramètres**
Accéder aux paramètres du système.
- Capture photo**
Prendre une photo.
- Modes d'affichage**
Changer de mode d'affichage.
- Verrouillage de fichier**
Démarrer l'enregistrement d'urgence (SOS) et verrouiller le fichier en cours.
- Lecture**
Consulter les vidéos et photos enregistrées.
- Enregistrement audio**
Activer ou désactiver l'enregistrement audio.
- IR (vision nocturne)**
Activer ou désactiver la vision nocturne infrarouge.

5. Paramètres

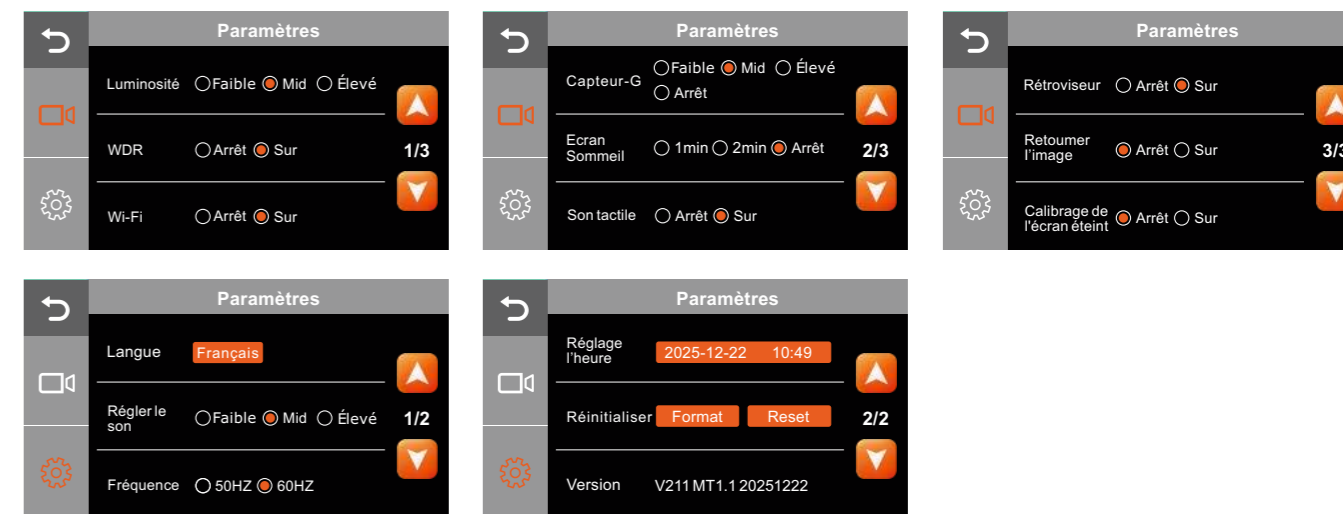

6. Deux Modes

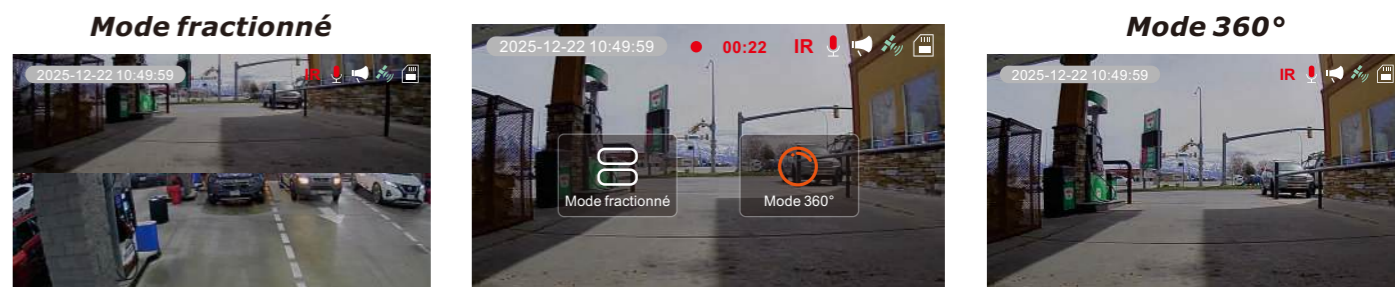

Coordonnées du support technique

Pour toute question concernant le **MiNy360X**, veuillez contacter votre revendeur ou le support technique RYDEEN :

- Téléphone: **1-310-787-7880** Fax: **1-310-787-7881**
- Email: tech1@rydeenmobile.com
- Web: <https://rydeenmobile.com/contact-support/>